



SBTL8200 Series

SBTL8200 Speed gates for additional lane

SBTL8211 Speed gates for additional lane

(w/ controller and RFID reader)

SBTL8222 Speed gates for additional lane

(w/ controller and fingerprint & RFID reader)

SBTL8233 Speed gates for additional lane

(w/ Visible light facial recognition devices)

SBTL8200 is designed to work with SBTL8000 series for forming multiple lanes.

Design

General device needs to have holes in the top cover before installing the reader head. In most cases, in order to quickly respond to the market, various types of barrier turnstiles are required to be in warehouse. In order to solve this problem, modularized structure design is used in the device. We integrate the reader, conversion board and top cover into a modular reader panel. The disassembly and installation of the reader head only need to pull the plug, without drilling holes in the top cover and purchasing new conversion board. Just prepare one model of SBTL8200 and multiple models reader panel in warehouse, that you can meet various market demands.

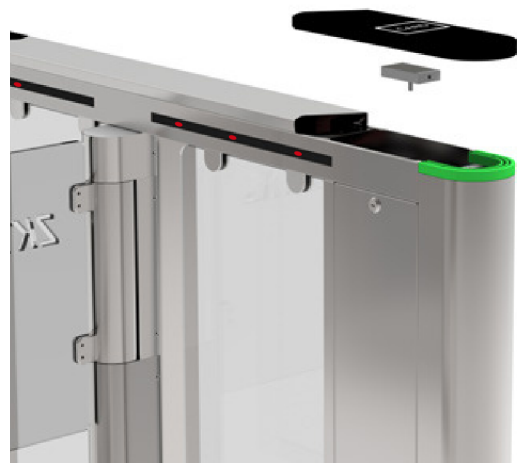

Performance

In order to improve the efficiency of pedestrian access management and user experience, we use a new type of servo motor. It makes the speed gates have faster opening speed and lower noise. The test results show that the opening speed can < 1.2 seconds when assembled the standard barrier panels, if assembled the mid-height barrier panels, the opening speed can < 0.8 seconds. Our infrared has increased to 10 pairs, which is 160% of the general device that can provide more accurate logic judgment.

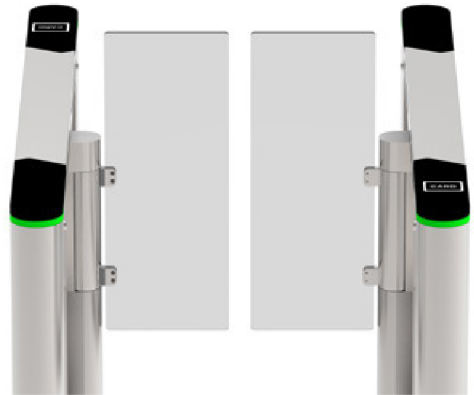

Quality

The covers and outer side panels made of superior quality stainless steel for exceptional durability. The barrier panels made of acrylic has better aging resistance and impact resistance. From raw material procurement to production, quality inspection has a perfect management system.



Features

- modular reader panel - respond to the market faster
- Servomotor Ser - faster opening
- Tailgate detection- 10 pairs of infrared sensors
- SUS304 stainless steel covers and outer side panel
- Long life cycle and low maintenance cost
- Easily integrated - RFID, fingerprint, face, etc.
- Bi-directional operational control
- LED passage indicator in both directions
- Convenient installation and maintenance
- Various optional panels
- Emergency mode - allow free access when power failures or emergency





Specifications

Power requirements	AC 100 ~ 120V/200 ~ 240V, 50/60Hz
Working temperature	-28°C~ 60°C
Working humidity	20%-95% (Non-condensing)
Working environment	Indoor
Speed of throughput	Maximum 40/ minute
Lane width(mm)	660
Footprint(mm*mm)	1600*870
Dimensions(mm)	L=1600, W=120, H=1200
Dimension with packing(mm)	L=1700, W=300, H=1130
Net weight(kg)	86kg
Weight with packing(kg)	100kg
Cabinet material	SUS304 Stainless Steel
Lid material	SUS304 Stainless Steel+Acrylic
Barrier material	Acrylic
Barrier movement	Swing
Emergency mode	Y
Security level	Medium

Optional panels

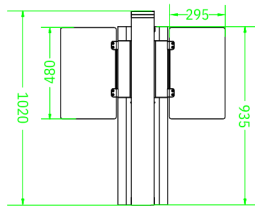

Low barrier panels

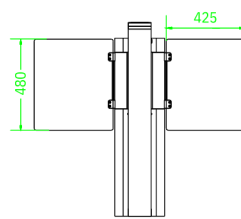

Wide barrier panels

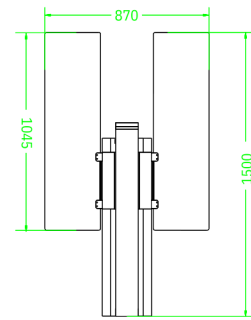

Extra height barrier panels

Dimensions (mm)

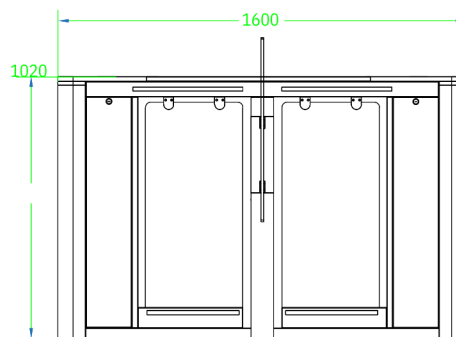
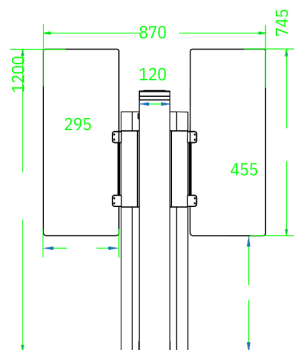

Distribuidor e instalador oficial

